

H pannello	Larghezza pannello	
630	2000	2500
830	2000	2500
1030	2000	2500
1230	2000	2500
1530	2000	2500
1730	2000	2500
2030	2000	2500

H piantana	N° Fissaggi
680	4
880	4
1080	4
1280	4
1580	6
1780	8
2080	8

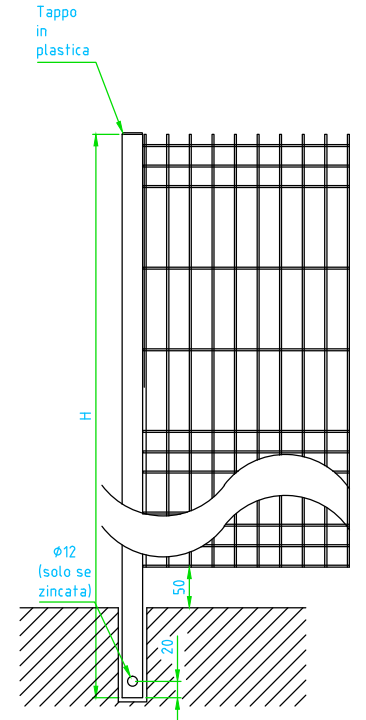
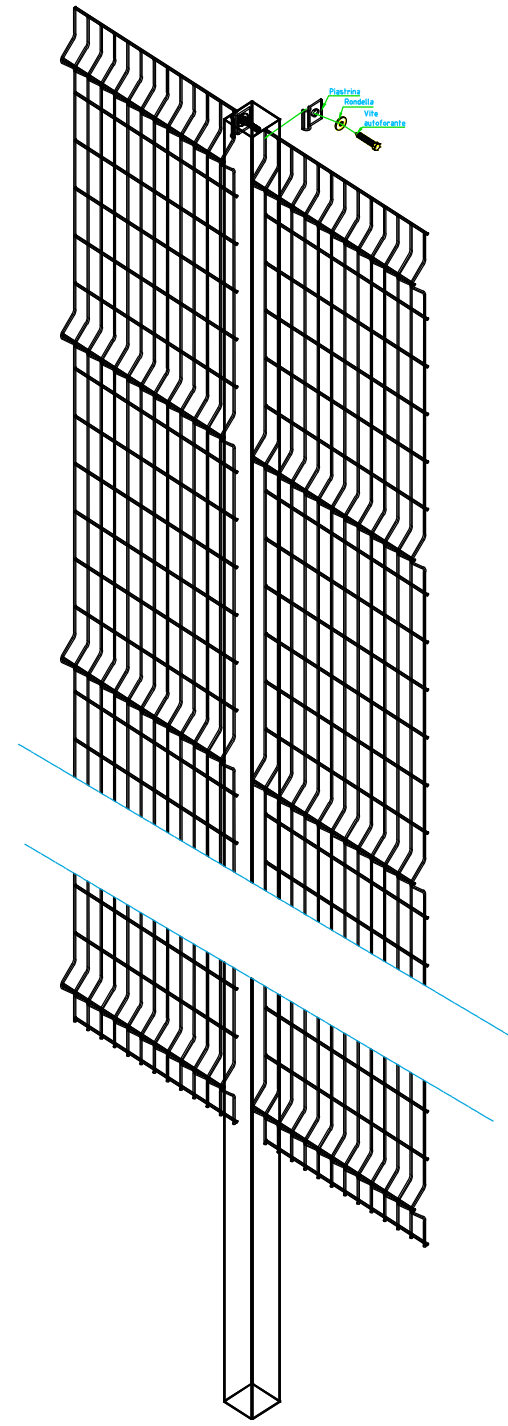

H pannello	Larghezza pannello	
630	2000	2500
830	2000	2500
1030	2000	2500
1230	2000	2500
1530	2000	2500
1730	2000	2500
2030	2000	2500

H piantana	N° Fissaggi
850	4
1050	4
1250	4
1550	4
1800	6
2050	8
2350	8

Quote generali escluso dove diversamente indicato : UNI 2768/1		Codice prodotto : RECINZIONE FAX	Materiale : S 235 JR	Tratt. sup. RAL 6005/9010 POLIESTERE
Firma _____	Data _____	Dimensioni:		
Dis. _____	Scheda tecnica recinzione FAX - Idonea per parchi giochi, giardini e residenziali			Peso : _____
Contr. _____	Montanti tubo 50x50			Nr. pezzi : _____
Approv. _____	Nr. disegno: RECINZIONE FAX - PIANTANA GARDEN			Nr. conferma ordine: _____
 Sede Legale : Via Kennedy n°1A 20044 Viggiù (MI) Sede Operativa : Via Provinciale 56 n°75 23070 Verdello (LC) Tel. +39 039514421 Fax +39 0395326529 P.IVA 0526770966 www.citterio.it - info@citterio.it		Originali CAD	Scala: _____	Formato: A3
		Foglio: 1/1	Rev. 1	

CARLO CITTERIO-Safety reserves all rights on this drawing and forbids any reproduction or conveyance to third parties without written authorization.

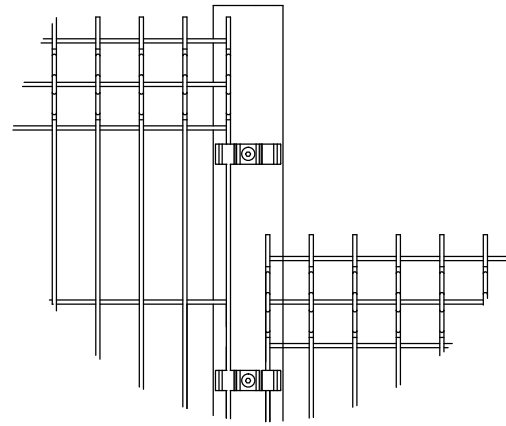

Salto di quota

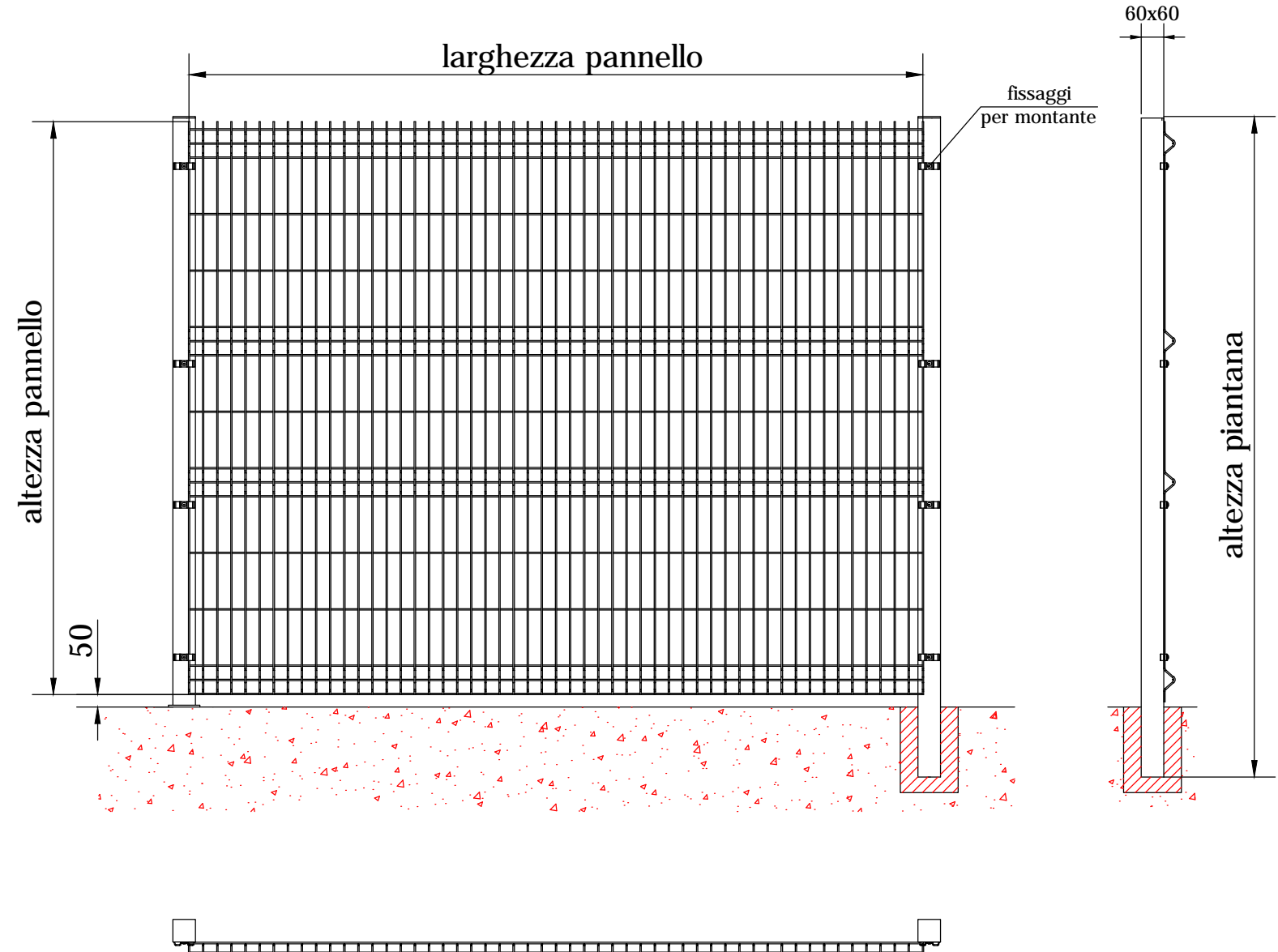
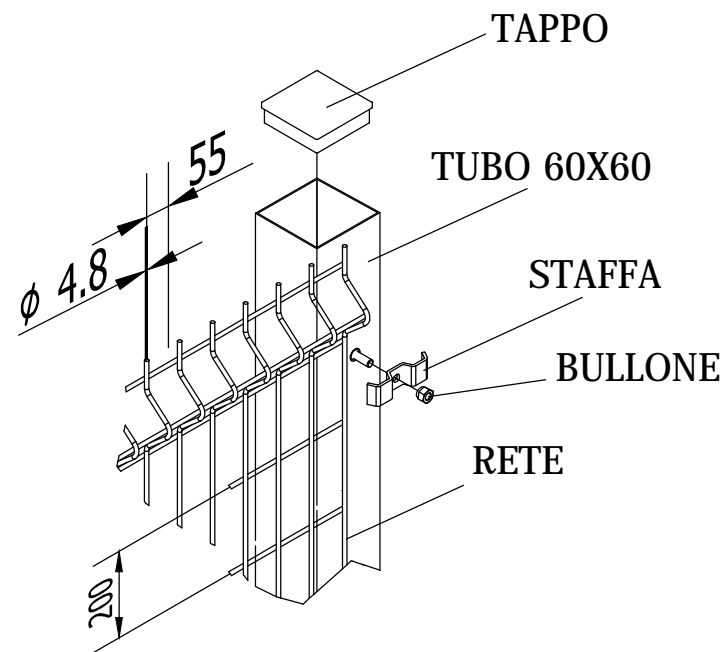
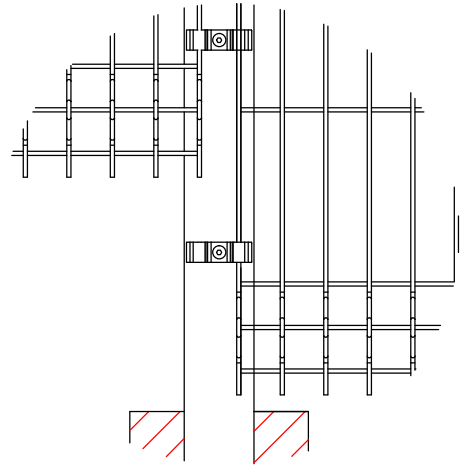

H pannello	Larghezza pannello	
630	2000	2500
830	2000	2500
1030	2000	2500
1230	2000	2500
1530	2000	2500
1730	2000	2500
2030	2000	2500

H piantana tassellare	N° Fissaggi
680	2
880	2
1080	2
1280	2
1580	3
1780	4
2080	4

H piantana cementare	N° Fissaggi
850	2
1050	2
1250	2
1550	2
1800	3
2050	4
2350	4

Quote generali escluso dove diversamente indicato : UNI 2768/1		Codice prodotto :	Materiale :	Tratt. sup. :		
Firma _____ Data _____		RECINZIONE FAX	S 235 JR	RAL 6005/9010 POLIESTERE		
Dis. _____	Scheda tecnica recinzione FAX - Idonea per parchi giochi, giardini e residenziali			Peso : _____		
Contr. _____	Montanti tubo 60x60			Nr. pezzi : _____		
Approv. _____	Nr. disegno: RECINZIONE FAX - PIANTANA MULTIPLA			Nr. conferma ordine: _____		
 Sede Legale : Via Kennedy n°1/A 20144 Tuggio (MI) Sede Operativa : Via Provinciale 56 n°168 20176 Verdello (LC) Tel. +39 039514441 Fax +39 0395202639 P.IVA 02266770962 www.citterio.it - info@citterio.it		Originali CAD	Scala:	Formato: A3	Foglio: 1/1	Rev. 1